

# STAR WARS

THE LEGACY COLLECTION™

**x3**  
1.5VAA or R6 size  
**NOT INCLUDED**

**BATTERIES REQUIRED**  
Alkaline batteries recommended. Phillips/cross head  
screwdriver (not included) needed to insert batteries.



**WARNING:**

CHOKING HAZARD—Small parts.  
Not for children under 3 years.

**AGES 4+**  
93994

## AT-AT™ ALL TERRAIN ARMORED TRANSPORT

Includes unassembled vehicle, speeder bike, figure, launchers, projectiles, label sheet, and instructions.

### ASSEMBLY:

Some assembly required.

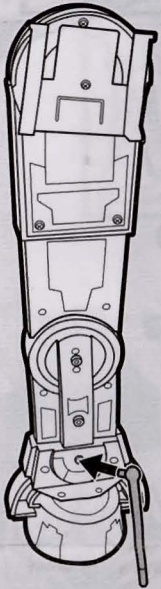

ATTACH RODS TO LEGS.

**X4**

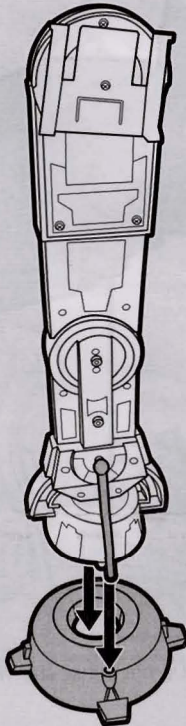

ATTACH LEGS TO FEET.

**X4**

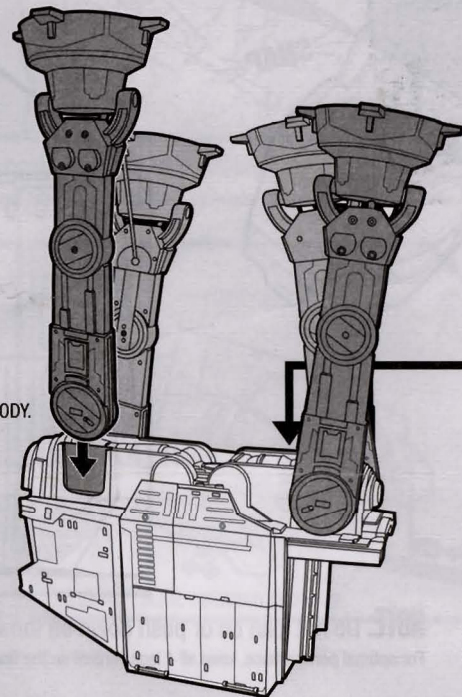

ATTACH LEGS TO BODY.

**NOTE:** Battery compartment is located on AT-AT's belly.

### IMPORTANT: BATTERY INFORMATION

#### ⚠ CAUTION:

1. Always follow the instructions carefully. Use only batteries specified and be sure to insert them correctly by matching the + and - polarity markings.
2. Do not mix old batteries and new batteries or standard (carbon-zinc) with alkaline batteries.
3. Remove exhausted or dead batteries from the product.
4. Remove batteries if product is not to be played with for a long time.
5. Do not short-circuit the supply terminals.
6. Should this product cause, or be affected by, local electrical interference, move it away from other electrical equipment. Reset (switching off and back on again or removing and re-inserting batteries) if necessary.
7. RECHARGEABLE BATTERIES: Do not mix these with any other types of batteries. Always remove from the product before recharging. Recharge batteries under adult supervision. **DO NOT RECHARGE OTHER TYPES OF BATTERIES.**

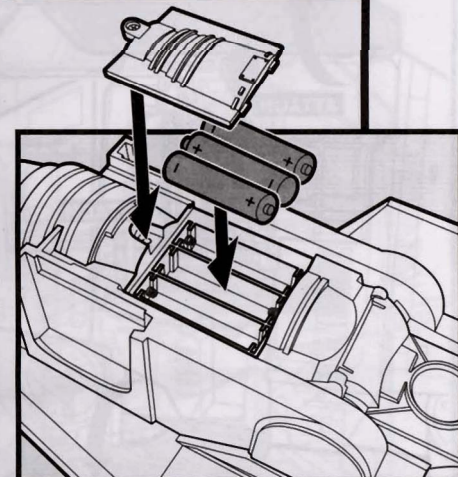

#### INSERT BATTERIES:

Using a Phillips/cross head screwdriver (not included), loosen screw in battery compartment door (screw remains attached to door). Remove door. Insert 3 x 1.5V "AA" or R6 size batteries (not included). Alkaline batteries recommended. Replace door and tighten screw.

# ASSEMBLY:

**1**

PEEL AND APPLY LABELS.

ATTACH

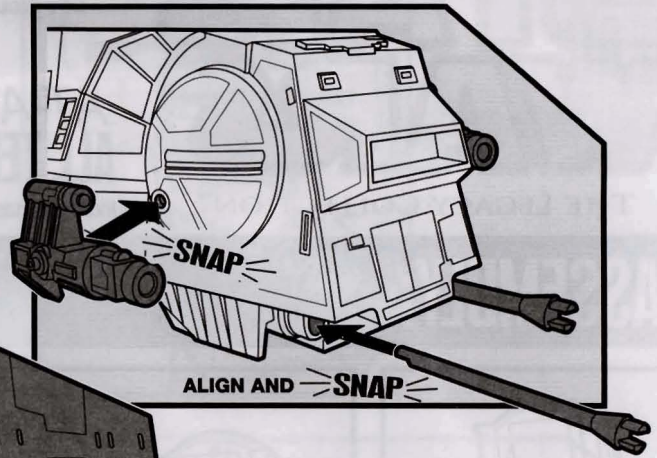

ALIGN AND SNAP

**2**

SNAP

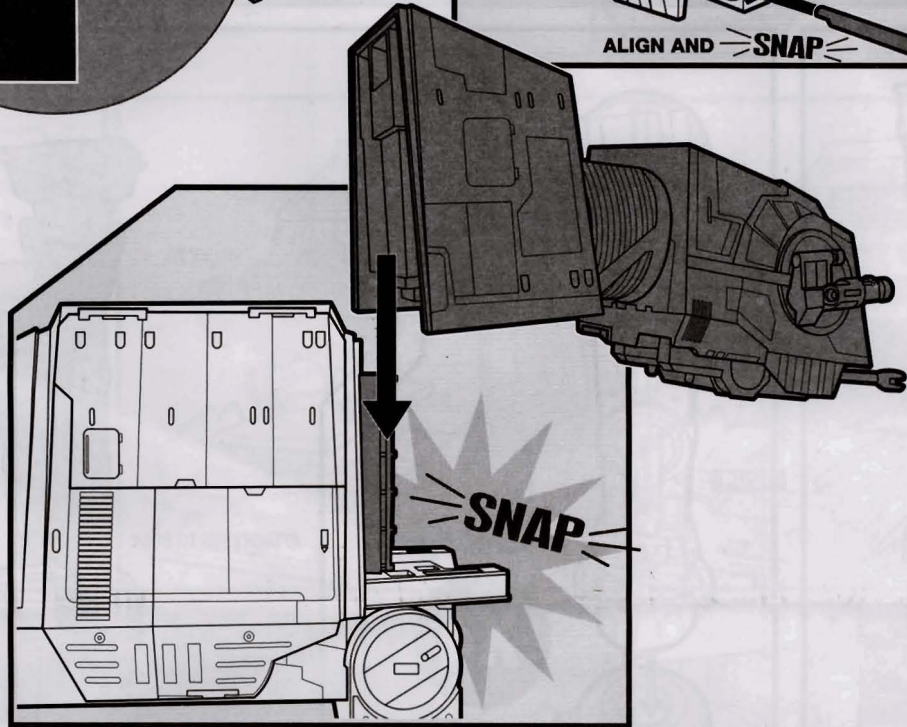

SNAP

**NOTE:** Do not lean on or push down on the vehicle's head. Do not sit on the vehicle. Do not cause the vehicle to fall over. For optimal performance, keep all 4 legs vertical on the floor at all times.



OPEN

PEEL AND APPLY LABELS.

PEEL AND APPLY LABELS.

## POWER SWITCH:

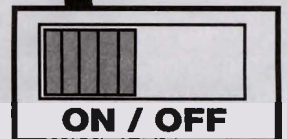
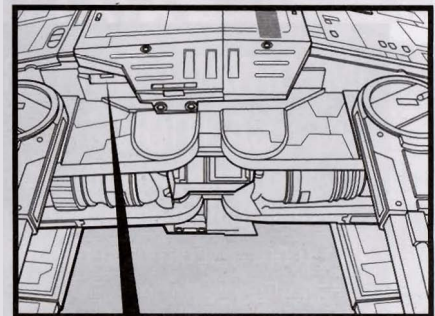

Turn Power Switch on AT-AT's belly to ON for full range of features.



ATTACH

ATTACH

OPEN

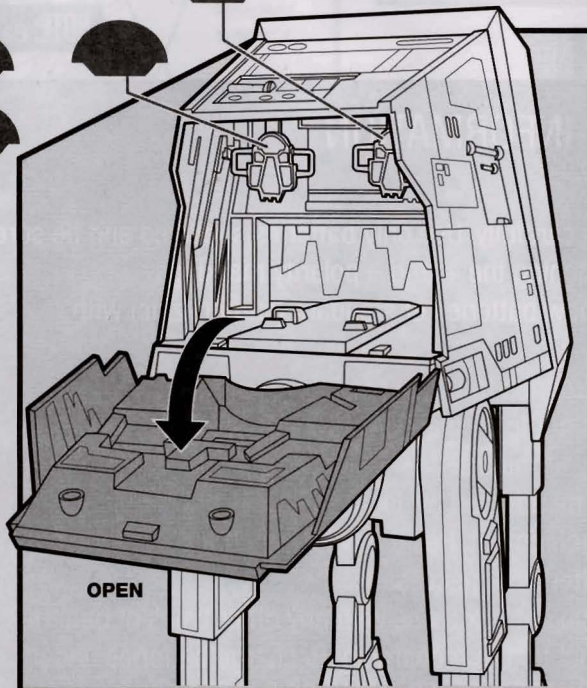

OPEN

**NOTE:** Remaining label application is optional.

# OPERATION:

## HEAD:

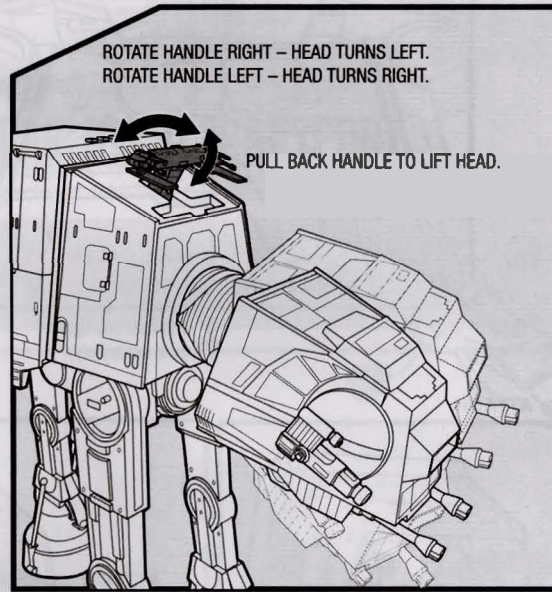
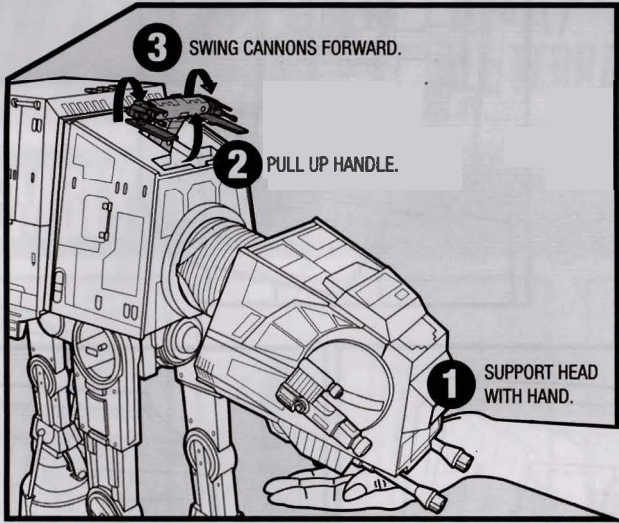

**NOTE:** Standard position for head is lowered.

To close handle, support head, swing cannons backward and snap handle into base.

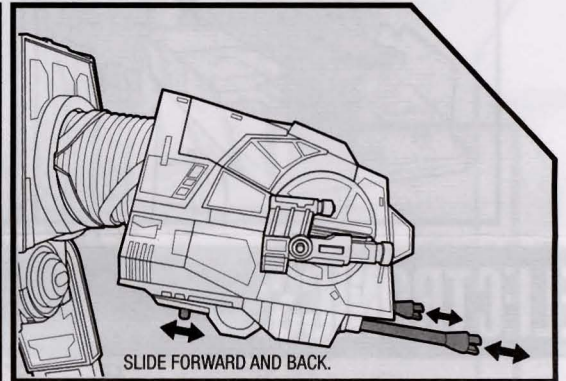
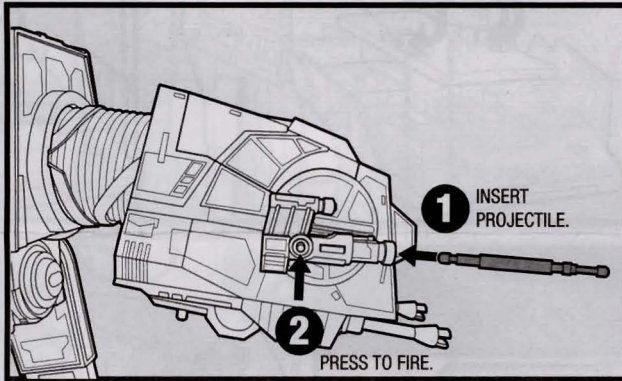
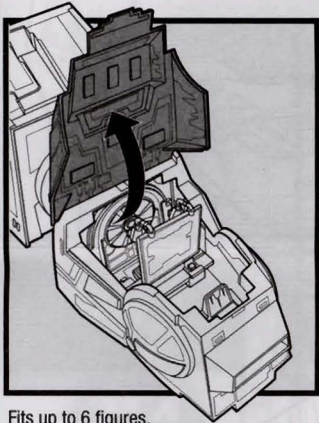

Fits up to 6 figures.  
(includes 1 figure; others sold separately)

## BODY:

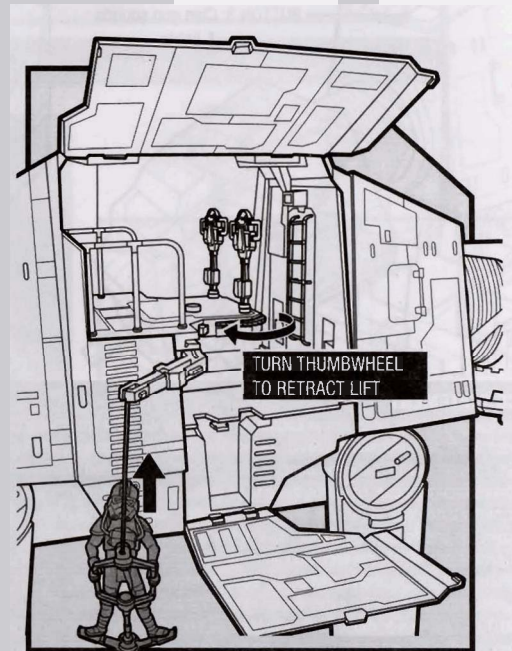
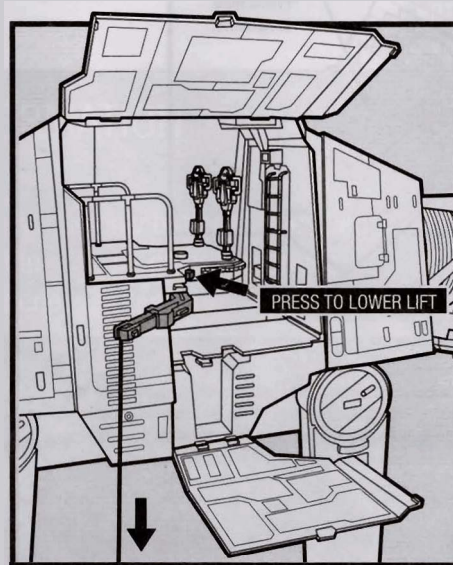
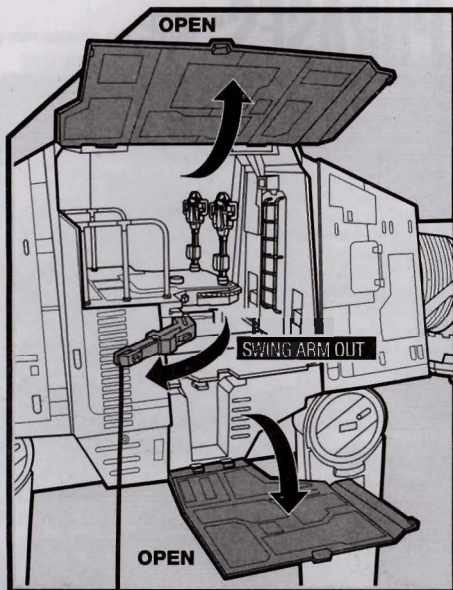

Second figure sold separately.

**NOTE:** Hand support required when placing figures on doors.



# BODY: (Continued)

# REAR:

PEEL AND APPLY LABELS.

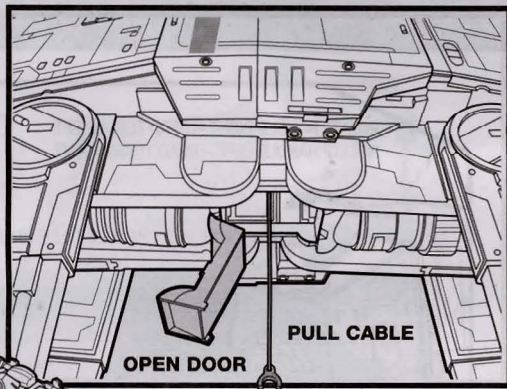
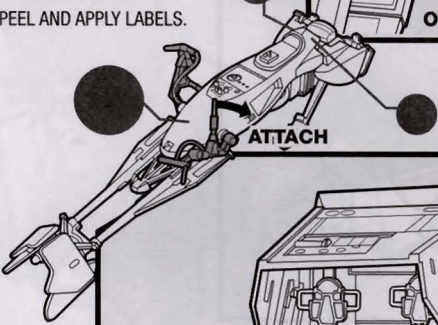

Will hold one figure.  
(sold separately)

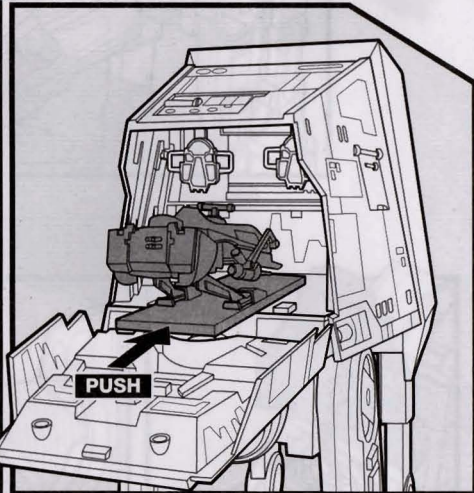
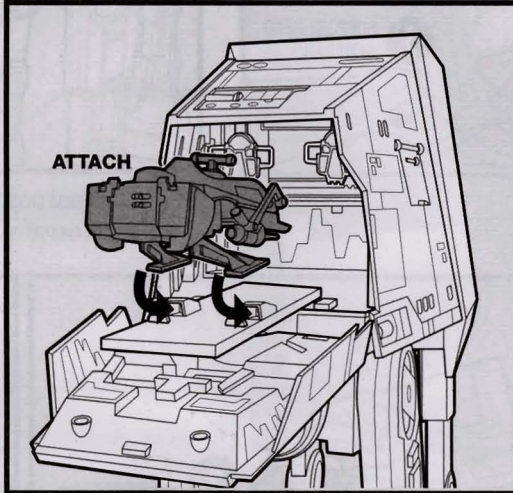
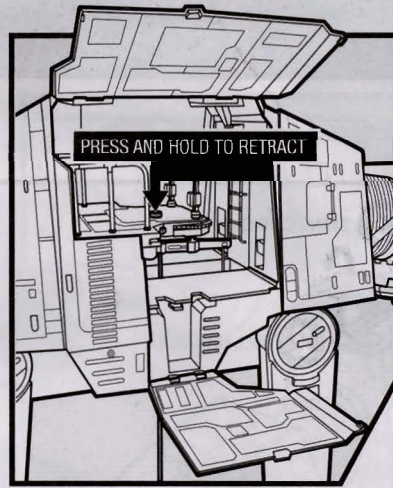

# ELECTRONICS:

Press or Press/Hold to Activate.

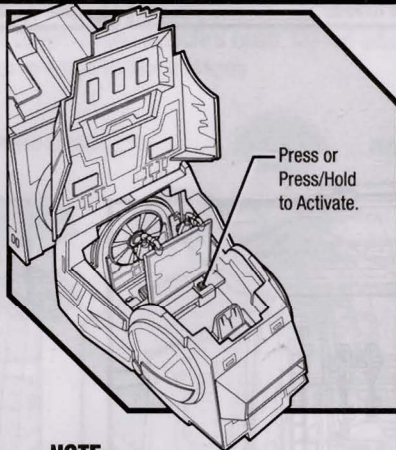
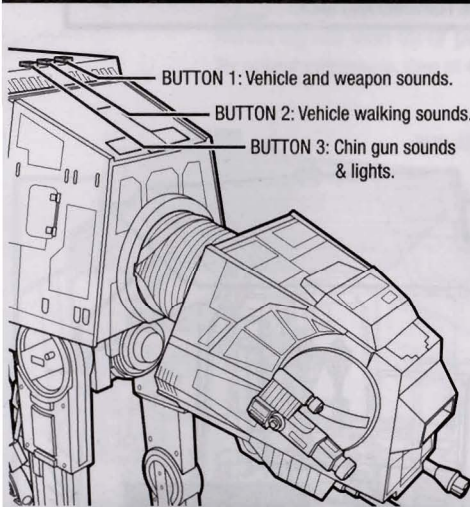

**NOTE:** Toy makes random sounds after buttons have not been pressed for several seconds.

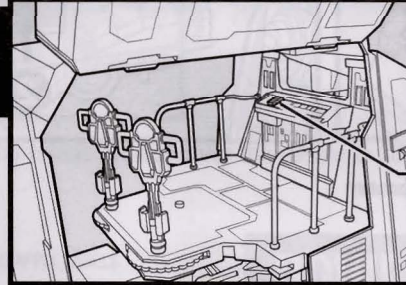

Press or Press/Hold to Activate.

# PHRASES:

**NOTE:** The phrases may play in a different order.

## Clone Trooper phrases:

- All right men load your weapons.
- Blizzard squadron objective completed.
- Ground troops deployed sir.
- Range to target, one-seven decimal twenty-eight.
- Preparing attack vectors.
- Primary guns charged and ready.
- Rebel base located.
- Rebel forces in range.
- Rebel forces spotted.
- We're taking heavy fire sir.

## Imperial Officer phrases:

- Forward defectors at full power.
- Launch speeder bike recon patrol.
- Rebel snowspeeder squadron approaching on your flank.
- Red light.
- Target the Rebel scum.
- Troops standing by for deployment.

## Darth Vader phrases:

- Don't fail me.
- Don't let Skywalker escape.
- That's it, the Rebels are there. And Skywalker is there with them.
- The Rebels are alerted to our presence.

## General Veers phrases:

- All troops will disembark for ground assault.
- Distance to power generators.
- I've reached the main power generators.
- Prepare to target the main generator.
- Target, maximum firepower.
- The shield will be down in moments.
- You may start your landing.

## FCC STATEMENT

This equipment has been tested and found to comply with the limits for a Class B digital device, pursuant to part 15 of the FCC Rules. These limits are designed to provide reasonable protection against harmful interference in a residential installation. This equipment generates, uses and can radiate radio frequency energy, and, if not installed and used in accordance with the instructions, may cause harmful interference to radio communications. However, there is no guarantee that interference will not occur in a particular installation. If this equipment does cause harmful interference to radio or television reception, which can be determined by turning the equipment off and on, the user is encouraged to try to correct the interference by one or more of the following measures:

- Reorient or relocate the receiving antenna.
- Increase the separation between the equipment and the receiver.
- Consult the dealer or an experienced radio/TV technician for help.

**CAUTION:** Changes or modifications to this unit not expressly approved by the party responsible for compliance could void the user's authority to operate the equipment.



Product and colors may vary.  
© 2009 Lucasfilm Ltd. & © or TM where indicated. All rights reserved.  
® and/or TM\* & © 2009 Hasbro. All Rights Reserved.  
TM & © denote U.S. Trademarks. PN#7028910000



Not suitable for children under 3 years because of small parts — choking hazard.